

INFORMATION FOR THE PATIENT

OVIDREL (choriogonadotropin alpha) offers the ease of use and convenience available with subcutaneous administration. Please familiarize yourself with the following instructions in order to understand how to self-administer OVIDREL.

Directions for Administration of OVIDREL in Pre-filled Syringe

OVIDREL in pre-filled syringes is intended for a single subcutaneous injection. Any unused material should be discarded. Ask your health care provider on how to dispose of used syringes and medicines no longer required. OVIDREL may be self-administered by the patient.

Follow the directions below for injecting OVIDREL.

Step 1: Getting ready

On a clean work surface, lay out the items listed below before you begin:

- One syringe of OVIDREL, 250 µg in a pre-filled syringe and the following which are not supplied with the product:
 - Alcohol wipes

Step 2: Cleanse

- Wash your hands thoroughly with soap and water.
- It is important that your hands and the items you use be as clean as possible.
- Needles should not touch any surface except alcohol-cleaned skin; keep them capped prior to use.

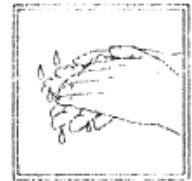

Step 3: Prepare Injection Site

- Select the site of injection (e.g. top of thigh, tummy). Refer to the injection site diagram
- Wipe the chosen area with an alcohol wipe, cleansing an area of approximately 5 cm x 5 cm. Lay the used side of the wipe next to your working surface or on the alcohol wipe wrapper.
- Pick up the syringe and remove the cap from the needle.
- Invert the needle and hold as if “throwing a dart”. With your other hand, gently squeeze the skin together to make a little elevation at the injection site. Using a “dart like motion”, insert the needle at a 90 degree angle. (You need very little force but quick action.)
- Once the needle is inserted into the tissue all the way, inject the solution by pushing gently on the plunger with your thumb of the hand holding the syringe. Take as much time as you need to inject all the solution.
- Immediately withdraw the needle and clean the site with the clean side of the alcohol swab using a circular motion. If there is minor oozing you may need to apply a small amount of pressure for a minute.

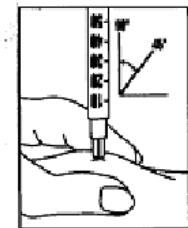
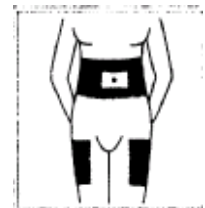

Step 4: Disposal of used Items

Once you have finished your injection, immediately discard the needles and syringe (without recapping the needle) into the disposal container.. Take the container to a clinic or pharmacy for proper disposal.

Directions for Administration of OVIDREL in Pre-filled Pen

- This section tells you how to use your pen.
- Before starting to use your pen, please read these instructions the whole way through first.
- This pen is for single use only. Only use it for you – do not let anyone else use it.



Follow the directions below for injecting OVIDREL

Step 1: Before you start

1. Wash your hands
It is important that your hands and the things you use are as clean as possible.
2. Find a clean area
A good place is a clean table or a kitchen surface.
3. Get together everything you need and lay them out:
 - 2 alcohol swabs
 - The pre-filled pen
 - A needle
 - Sharps container (Not supplied with the product)

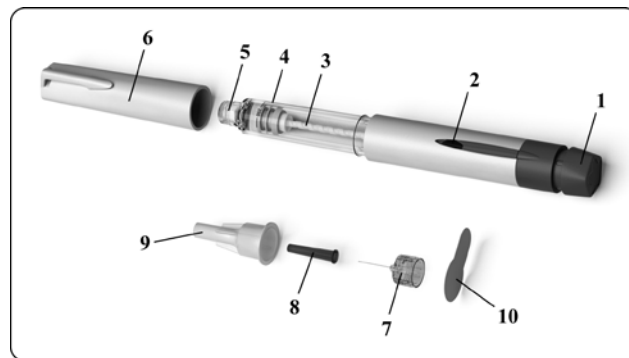

- | | |
|------------------------------|------------------------|
| 1. dose setting knob | 6. pen cap |
| 2. dose display | 7. removable needle |
| 3. plunger piston | 8. inner needle shield |
| 4. reservoir holder | 9. outer needle cap |
| 5. threaded needle connector | 10. peel off seal tab |

Please note: The scale that can be seen on the reservoir holder is to show how much of the medicine is left in the pen. **Do not use it to set the dose.**

Step 2: Getting your pen ready

1. Take off the pen cap

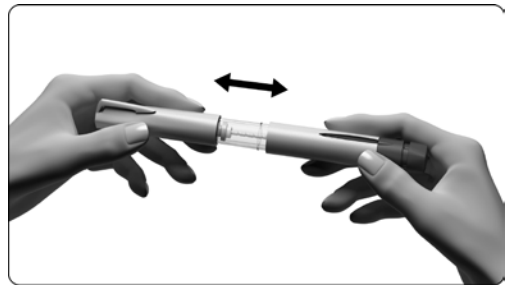

2. Put on a needle

- Take a new needle. Only use the ‘single use’ needle supplied for the OVIDREL pre-filled pen.
- Check that the peel tab closing the outer needle cap is not damaged or loose. If it is damaged or loose, do not use the needle and get another. Throw away the unused needle with the outer needle cap still on, in your household garbage.
- Remove the peel tab from the outer needle cap.
- Hold the outer needle cap firmly.
- Press the threaded needle connector into the outer needle cap. Twist the outer needle cap clockwise until it is firmly fixed.
- Remove the outer needle cap by pulling it gently. Leave the inner needle shield in position.
- Do not throw away the outer needle cap – you will need it again later to help take off the needle.

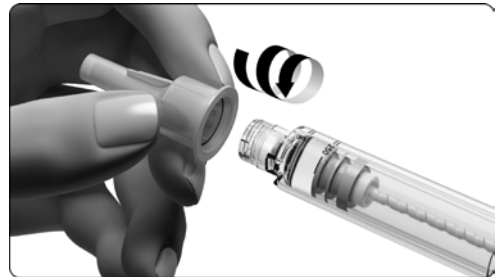

Caution: Make sure that the needle is securely fixed before starting your injection.

Step 3: Removing large air bubbles and setting your dose

1. First remove any large air bubbles

An air bubble is large if it fills the top of the reservoir holder when you are holding the needle pointing upwards. Small air bubbles that stick to the side walls of the reservoir holder do not need to be removed.

- If you do not notice a large air bubble, please go straight to the next step ‘**How to set your dose**’.
- If you notice a large air bubble:
 - Gently turn the dose setting button clockwise until you see a dot (●) in the dose display. If you pass this position, simply turn the dose setting knob back until you can see the dot (●).

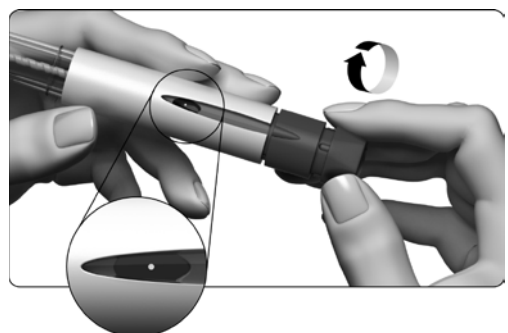

- Carefully remove the inner needle shield.
- Hold the pen with the needle pointing upwards.
- Using your other hand, tap the reservoir holder gently with your finger so that the air bubble rises up towards the needle.
- With the needle still pointing upwards, slowly press the dose setting button in as far as it will go.
- A drop of liquid will appear at the tip of the needle. This shows that the air has been removed. Now go to ‘How to set your dose to “250”’.

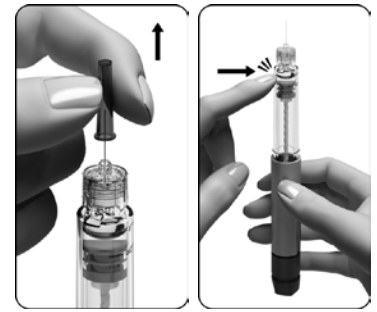

2. How to set your dose to ‘250’

Gently turn the dose setting button clockwise. The dose display will show a straight line and you have to keep turning until you can read the number ‘250’. Do not push or pull the dose setting button while you turn it.

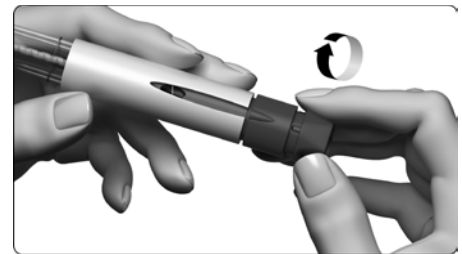

- If not already done while removing air, carefully remove the inner needle shield.

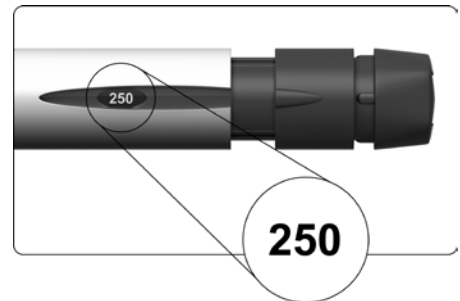

Step 4: Injecting your dose

1. Choose the place to give the injection
 - Where your doctor or nurse has told you – usually on your upper thighs or abdomen.
2. Clean the skin where the injection is going
 - Wipe the skin with your first alcohol swab – use a circular motion.
 - Let it air dry before injecting.
3. Check again that the number in the dose display reads ‘250’
 - If needed, turn the dose setting button clockwise or counter clockwise to adjust to ‘250’.
4. Inject the dose as you were told to by your doctor or nurse
 - Insert the needle into your skin as your doctor or nurse has shown you

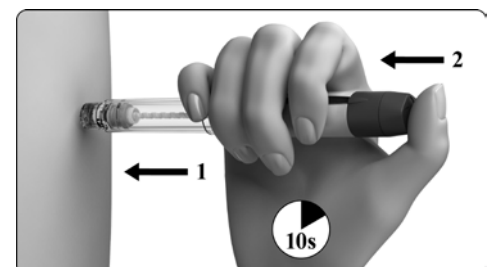
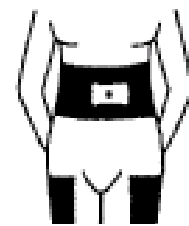

- Slowly press the dose setting button in as far as it will go.
- Keep the needle in your skin with the dose setting button still pressed in – for at least 10 seconds.
- The dose number shown in the dose display will turn back to ‘0’. This shows that the complete dose was delivered.
- Keeping the dose setting button pressed in, take the needle out of your skin.
- Use the second alcohol swab to gently apply pressure where you have just injected.

5. Check that the dose display reads ‘0’

- This confirms that your dose has been fully delivered. **Do not attempt to inject a second time.**

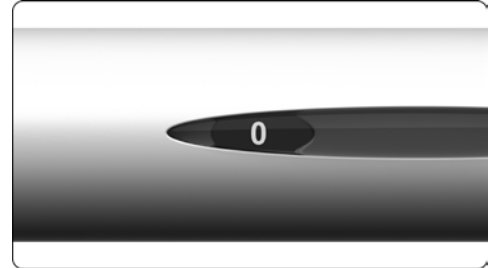

Step 5: After the injection

1. Taking off the needle

- Hold the pen firmly by the reservoir holder.
- Carefully put the outer needle cap back onto the needle. Be careful not to prick yourself with the needle.

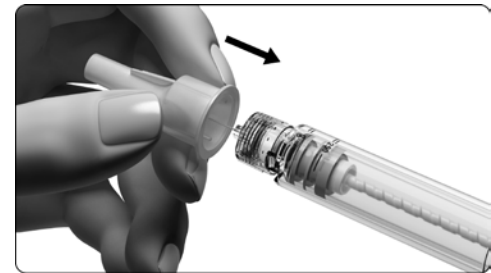

- Grip the outer needle cap and unscrew the needle by turning the cap counter clockwise.

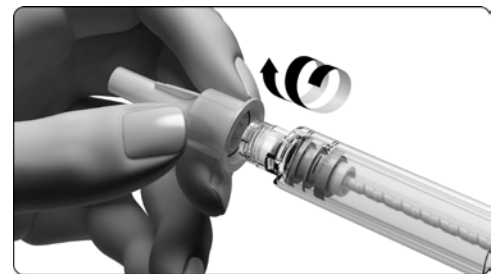

2. Disposal

- Use each needle and pen only once.
- Throw away the used needle safely in a sharps container.
- Put the outer needle cap back on any needle so that it is safe to be thrown away.
- Please consult your health care provider on how to dispose of the Ovidrel[®] pen and medicines no longer required.

Storing the pre-filled pen

- Stability and storage recommendations are provided on page 10.
- Refer to the date indicated on the labels for expiry date. Do not use after expiry date.
- Solutions of pre-filled pens are stored at 2°C - 8°C (in a refrigerator).
- Do not freeze. Protect from light.
- Do not use the Ovidrel[®] pre-filled pen if the solution contains particles or is not clear.

If you have any further questions on the use of this medicine, ask your doctor or pharmacist.

QUESTIONS AND ANSWERS

Q. What is OVIDREL (choriogonadotropin alpha)?

A. OVIDREL is the only recombinant human chorionic gonadotrophin (r-hCG). Its generic name is choriogonadotropin alpha. It is produced as a solution in a pre-filled syringe or a pre-filled pen that is intended for subcutaneous injection following reconstitution with Sterile Water for Injection, USP/Ph.Eur. OVIDREL ensures that you are receiving the highest purity hCG on the market. Subcutaneous injections offer the advantage of being convenient and easy to self-administer.

Q. What does OVIDREL do?

A. OVIDREL is used to trigger ovulation in infertile women with ovarian dysfunction.

Q. What is hCG?

A. Human chorionic gonadotrophin, or hCG, is a hormone that is involved in reproduction in women. It is found in the urine of pregnant women and is produced by the placenta.

Q. Who can take OVIDREL?

A. OVIDREL is indicated for women following the stimulation phase of infertility treatment.

Q. What is the amount of OVIDREL that must be injected?

A. 250 µg in a pre-filled pen, 250 µg in 0.5ml for the ready to use solution packaged in a pre-filled syringe or 250 µg in 1 mL (1 cc) of Sterile Water for Injection for lyophilised product which must be reconstituted.

In case of a drug overdose, contact a health care practitioner, hospital emergency department or regional Poison Control Centre immediately, even if there are no symptoms.

Q. What are the side effects associated with the use of OVIDREL?

A. As with other hCG preparations, side effects can occur with the use of OVIDREL: discomfort at the injection site, stomach pain, nausea, and vomiting have been reported. Ask your fertility team to discuss the possible side effects with you. As with all medications, it is important to report any physical changes and all symptoms to your healthcare professional.

Q. What risk is there of developing OHSS while on OVIDREL?

A. Contact your doctor if you experience severe pain or bloating in the stomach or pelvic area, severe upset stomach, vomiting, or weight gain, as these are symptoms of a medical event called Ovarian Hyperstimulation Syndrome (OHSS). OHSS occurs infrequently (usually less than 3% incidence). However, because OHSS can progress rapidly to a serious medical event, OVIDREL should be stopped at the first signs of OHSS.

Q. Is OVIDREL associated with multiple births?

A. Reports of multiple births have been associated with fertility treatments. You should discuss the potential risk of multiple births with your doctor before beginning treatment.

Q. Is OVIDREL associated with congenital birth defects?

A. There is no evidence to establish an association between the administration of OVIDREL to female patients and the occurrence of congenital anomalies in their offspring. The data supporting this

position is derived from the conclusions of clinical trials, as well as from post-marketing information where no cases of congenital anomalies have been reported since the introduction of OVIDREL to the market. Moreover, based on large epidemiological studies published in the literature, the rate of major or minor congenital anomalies following assisted reproductive technology procedures is consistent with that found in the unassisted population. It must be noted that these epidemiological studies relate to clinical trials carried out with urinary drugs. There is, however, no ground to suspect that, with regards to this particular risk, the recombinant product would be different from similar drugs of urinary origin.

Q. Can I take OVIDREL with other medications?

A. Please inform your doctor and pharmacist if you are taking or have taken any other medications, even those not requiring a prescription.

While the information contained in the "information for the patient" section provides important information about OVIDREL, it does not contain all the possible uses, actions, precautions, side effects, warnings, contraindications, and interactions of this medication. For more detailed information, please be sure to consult the package insert for this product and to discuss any questions you may have with your physician prior to beginning therapy.

Reporting Suspected Side Effects

You can report any suspected adverse reactions associated with the use of health products to the Canada Vigilance Program by one of the following 3 ways:

Report online at www.healthcanada.gc.ca/medeffect

Call toll-free at 1-866-234-2345

Complete a Canada Vigilance Reporting Form and:

Fax toll-free to 1-866-678-6789, or

Mail to:

Canada Vigilance Program

Health Canada

Postal Locator 0701E

Ottawa, Ontario

K1A 0K9

Postage paid labels, Canada Vigilance Reporting Form and the adverse reaction reporting guidelines are available on the MedEffect™ Canada Web site at www.healthcanada.gc.ca/medeffect.

NOTE: Should you require information related to the management of side effects, contact your health professional. The Canada Vigilance Program does not provide medical advice.